

NITRO

iDrive
USB 3.0
with Lightning
for iOS & Mac/PC





For iPhone, iPad and PC/Mac.

Strontium® iDrive USB 3.0 can securely store and share digital contents such as movies, pictures, and music from your iPhone and iPad to your Mac or PC computer and vice versa with amazing transfer speed using its dual 8-Pin lightning and standard Type A USB 3.0 connectors.



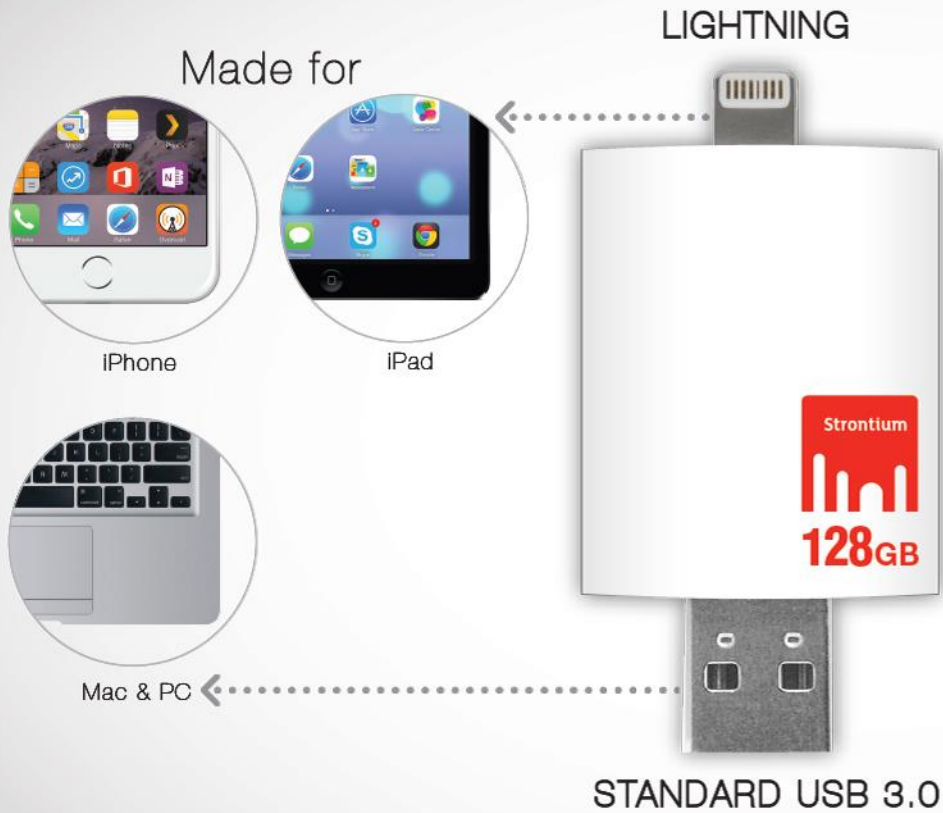

6 reasons to choose Strontium



Secured
Data Storage



Direct Playback of
Videos & Songs



Super Speed
USB 3.0



Backup & Restore
Contacts, Calendars
& Camera roll



Free App for Auto
File Management &
Security



2 Years
Limited Warranty

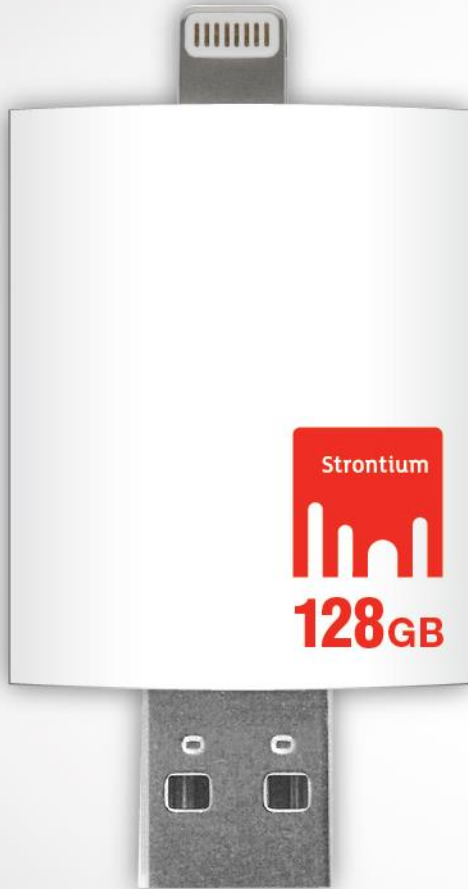

Product Features.

- Connections - 8-Pin Lightning / Standard USB 3.0
- Colour - ○ White
- Mobile device compatibility - iPhone and iPad with Lightning connector and iOS 8.0 and higher
- PC/ Mac compatibility - Windows XP, Windows 7, Windows 8, Mac OS X v10.6+.
- Transfer Speed USB - Superspeed USB 3.0
- Guaranteed - 2 Years Strontium® limited warranty

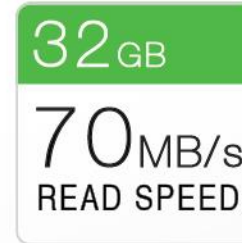
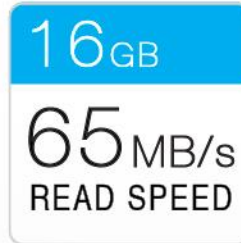

Product Specification.

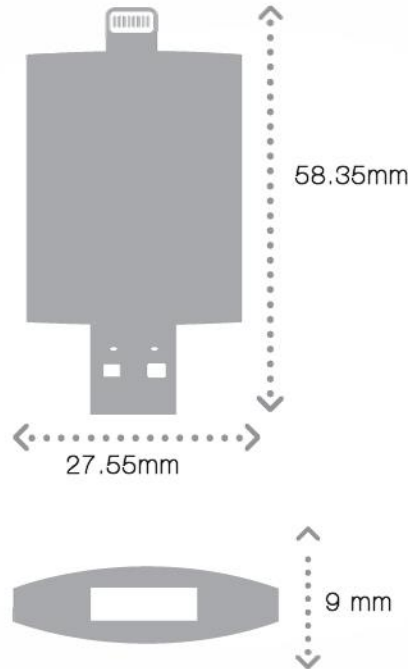

- Available Capacities 16GB / 32GB/ 64GB/128GB
- Dimensions 58.35 x 27.55 x 9.0 (L x W x D in millimetres)
- Product Weight 11.54 grams
- Operating Temperature 0°C to 65°C
- Storage Temperature -40°C to 85°C
- System Requirement



i-FlashDrive ONE APP
from AppStore

I-FlashDrive ONE

iPhone



iPhone 6 Plus



iPhone 6



iPhone 5S



iPhone 5C



iPhone 5

iPad



iPad Air 2



iPad Air



iPad mini 3



iPad mini 2



iPad mini

Supported Models.

Strontium® iDrive USB 3.0 is compatible with iPhone and iPad with lightning connector and iOS 8.0 and higher.





Direct File Transfer.

The iFlashDrive ONE App makes file transfer easy. Simply copy the files to the iDrive, remove and plug into the device you wish to copy the files to.



Without network.

iDrive and iFlashDrive ONE App work without network connection. Anywhere or anytime, access or share your files with convenience.



Free APP for iPhone and iPad.

Together with the i-FlashDrive ONE App. you now have the most powerful accessory available for your iPhone and iPad today. Bringing together all your files such as Music, Video, Photos and Documents into one convenient place has never been easier. The iFlashDrive ONE App allows you to transfer all your files quickly and easily without any worries about file types, converting or syncing between all your iOS devices and even Mac/PC, it is that simple.

Uniquely, iDrive.

i-FlashDrive ONE APP



iCloud



iTunes



Convenience	Direct access to your device through the APP	Need to connect to PC	Need to connect to PC
Extra Storage	16GB / 32GB / 64GB	5GB free usage / Photo stream only lasts for 30 days	5GB free usage
Portability	Portable with your iPhone/iPad	Portable with your phone or need to access through a PC	Need to access through a PC
Requirements	No WiFi / Network / Battery needed	Need network connection	Need network connection and Mac / PC

Comparing using iDrive with iCloud & iTunes.



APP Features and Functionality

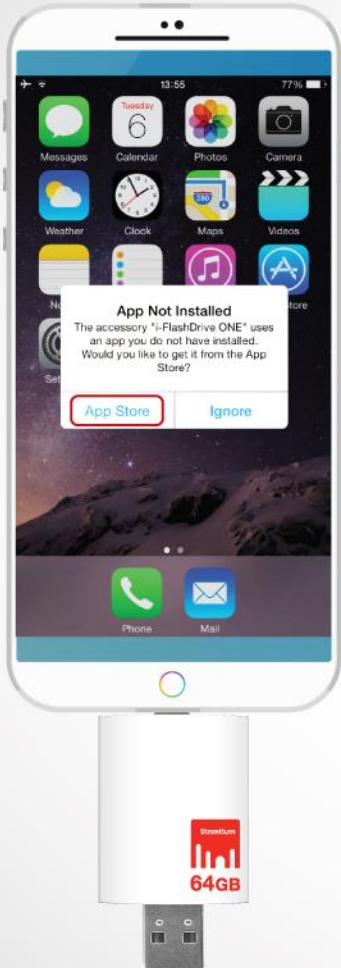

Upon inserting Strontium® iDrive USB 3.0 into the iPhone or iPad, an automatic prompt for APP installation will appear. Click on "App Store" to proceed with installation.

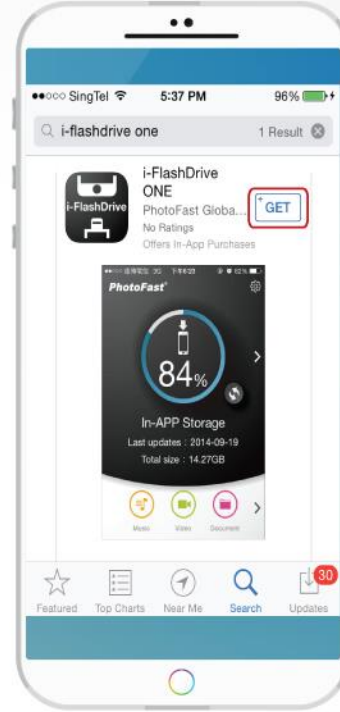

if the automatic prompt does not appear, please go to "App Store" and download i-FlashDrive ONE APP.



Scan for Download

APP Installation Guide.

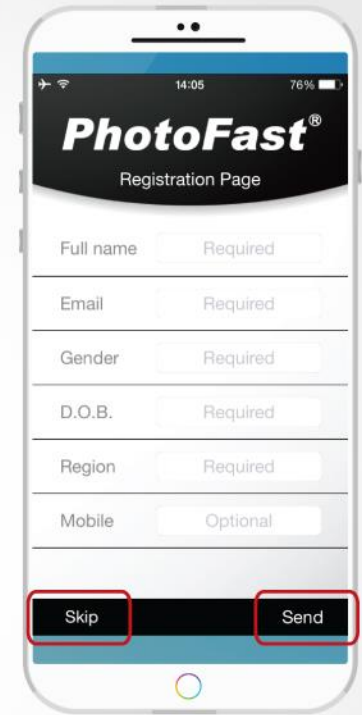

Authentication is required to identify the iDrive.
Once done, click "Get Started" to proceed.

A Registration Page will be prompted.
User may either proceed to input the
required details to **encrypt** all data
stored in the iDrive or click "Skip" to
bypass this portion.

APP Installation Guide.

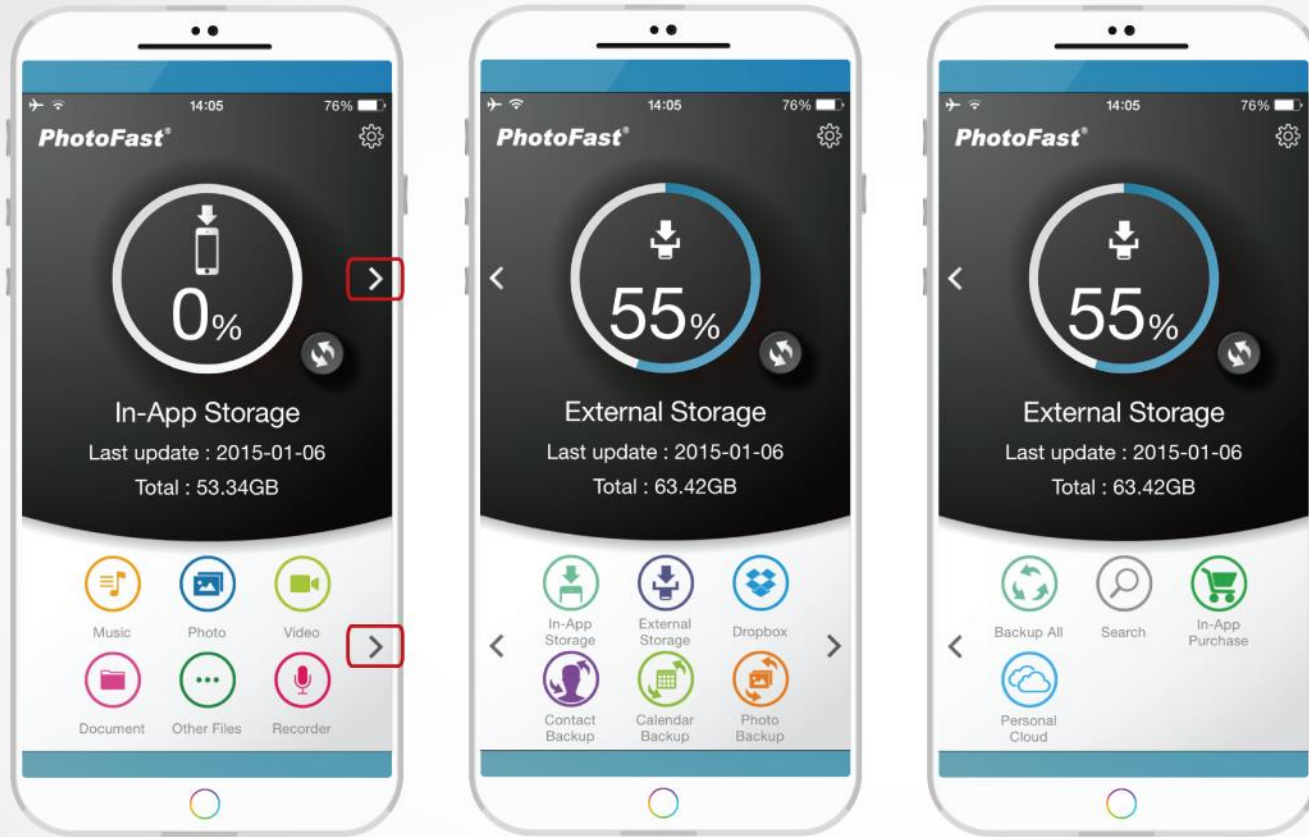

Top portion shows the available storage space in the Strontium iDrive and user's device (iPhone or iPad).

Bottom portion gives quick access to files and backup functions.

APP Features - Home Page.



















Clicking the gear icon on the top right hand corner will bring user to the Settings page.

APP Features - Home Page.



Clicking the percentage wheel icon in the center will display the breakdown of the data in stored.

APP Features - Home Page.

	Music	Access and listen to audio files.		Dropbox	Link and access Dropbox within the app.
	Photo	Access and browse image files.		Contact Backup	Backup and restore Contact List.
	Video	Access and watch video files.		Calendar Backup	Backup and restore Calendar.
	Document	Access and read document files.		Photo Backup	Backup and restore Camera Roll.
	Other Files	Access to unsupported files and choose to open with other third part APP.		Backup All	Backup Contact /Calendar /Photo with one push button.
	Recorder	Access to voice memo recorder.		Search	File/Folder search function.
	In-App Storage	File manager to access files stored within the app.		In-App Purchase	Advanced functions for purchase when they are ready.
	External Storage	File manager to access files stored on the iDrive.		Personal Cloud	Backup cloud data to the iDrive.

APP Functionality.

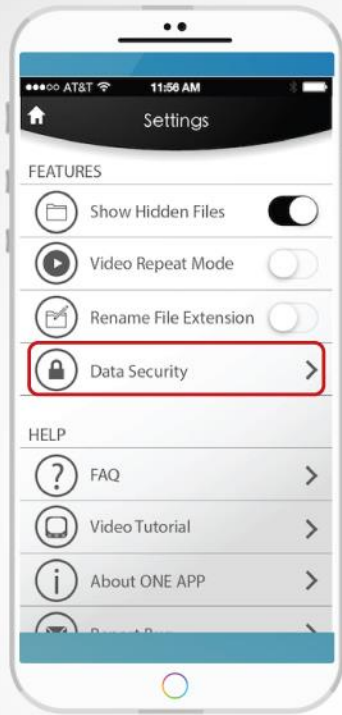

Settings page for turning features ON/OFF



Data Security page



Password setting for security purposes



Retrieve your password through your registered email address

Data Security and APP Password Setting.



Supported File Formats.



**16
GB**

P/N: SR16GWHOTGAZ

UPC: 8886450705410

**32
GB**

P/N: SR32GWHOTGAZ

UPC: 8886450705427

**64
GB**

P/N: SR64GWHOTGAZ

UPC: 8886450705434

**128
GB**

P/N: SR128GWHOTGAZ

UPC: 8886450705717

Part Number and UPC Barcode.